

**Dimensions**

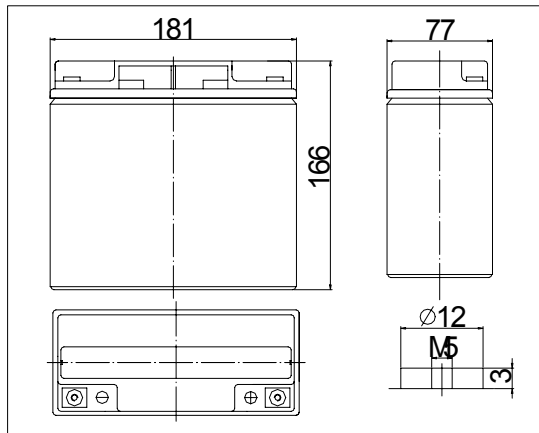

**Discharge Characteristics(25°C)**

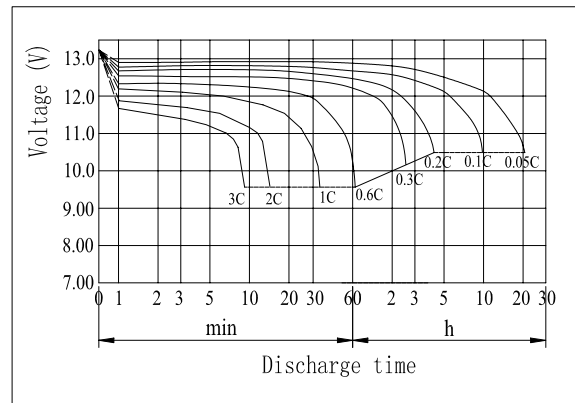

**Specifications**

Nominal Voltage		12 V
Capacity(20HR, 25°C)		22Ah
Dimension	Length	181mm +/- 1mm
	Width	77mm +/- 1mm
	Height	166mm +/- 1mm
	Total Height	166mm +/- 1mm
Approx. Weight		6.40kg
Internal resistance (Fully charged, 25°C)		Approx. 14mΩ
Capacity affected by temperature (20HR)	40°C	102%
	25°C	100%
	0°C	85%
	-15°C	65%
Self-discharge (25°C)	3 month	Remaining Capacity: 91%
	6 month	Remaining Capacity: 82%
	12 month	Remaining Capacity: 65%
Nominal operating temperature		25°C±3°C
Operating temperature range		-15°C-50°C
Float charging voltage(25°C)		13.60 to 13.80V
Cyclic charging voltage(25°C)		14.50 to 14.90V
Maximum charging current		8.8A
Terminal material		Copper
Maximum discharge current		330A(5 sec.)

- Absorbent glass mat technology;
- Recognized by UL & CE;
- Flame retardant ABS container (UL94V-0/ 94V-2).

**Charging Characteristics(25°C)**

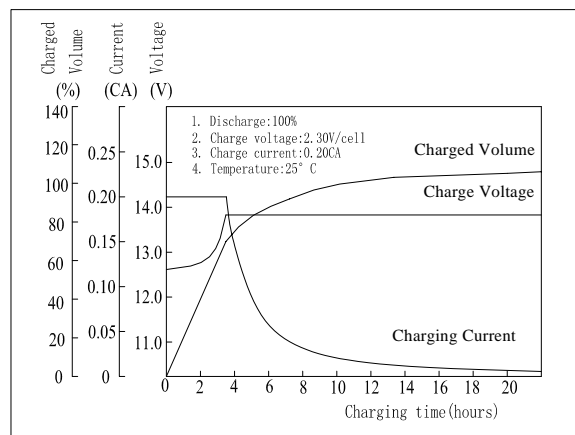

**Cycle Life(25°C)**

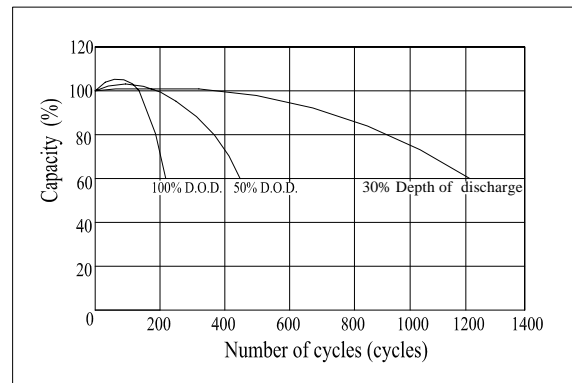

Note: Floating life at 25°C designed for 3 to 5 years.

**Constant Current Discharge Characteristics (A, 25°C)**

F.V/TIME	5min	10min	15min	30min	60min	3h	5h	10h	20h
9.60V	83.6	52.8	41.8	24.2	14.3	5.58	3.80	2.05	1.12
10.2V	79.4	50.2	40.1	23.2	13.7	5.50	3.74	2.04	1.11
10.8V	74.7	47.2	38.1	22.1	13.0	5.39	3.67	2.02	1.10

**Constant Power Discharge Characteristics (Watt, 25°C)**

F.V/TIME	5min	10min	15min	30min	60min	3h	5h	10h	20h
9.60V	933	596	477	277	166	66.3	45.3	24.7	13.4
10.2V	886	566	457	266	159	65.3	44.7	24.4	13.3
10.8V	833	532	435	253	151	64.0	43.8	24.4	13.2